



BUSHFIRE MITIGATION TERMINOLOGY & STANDARDS

Version 3

Last Reviewed: September 2020

SHIRE OF DENMARK BUSHFIRE MITIGATION TERMINOLOGY & STANDARDS

CONTENTS

FIRE BREAKS / FIRE ACCESS TRACKS	2
STRATEGIC BREAK	3
COMMON DRAINAGE TECHNIQUES	5
PARKLAND CLEARING.....	5
MULCHING	7
SLASHING	7
CHEMICAL SPRAYING	8
DIEBACK	9
WEEDS.....	9
TREE PRUNING/TRIMMING.....	10
ASSET PROTECTION ZONE.....	11

FIRE BREAKS / FIRE ACCESS TRACKS

A fire-break is a strip of land that has been cleared of all trees, shrubs, grass and other combustible material, providing a 'fuel free' area. Fire-breaks are intended to allow access for fire fighting vehicles and can provide a fuel free area from which prescribed burning can be undertaken. They may slow or stop the spread of a low-intensity bushfire however they should not be relied upon to prevent the spread of a fire. Fire-breaks are often constructed with a machine such as a dozer, front end loader, grader, tractor or skid-steer loader. In some situations, a suitable fuel-free area may be created by other methods such as hand tools, ploughing, herbicide treatment, grazing stock and controlled fire.

Unless otherwise specified, fire access tracks in the shire of Denmark should have a:

- Four (4) meter trafficable surface
- Five (5) meter vertical clearance
- One (1) meter low fuel area either side of the trafficable surface, this can be slashed or parkland cleared depending on vegetation type
- Mineral earth or slashed no greater than 50mm
- Turn around or passing bay every 200m
- Constructed to allow for appropriate drainage * see drain types

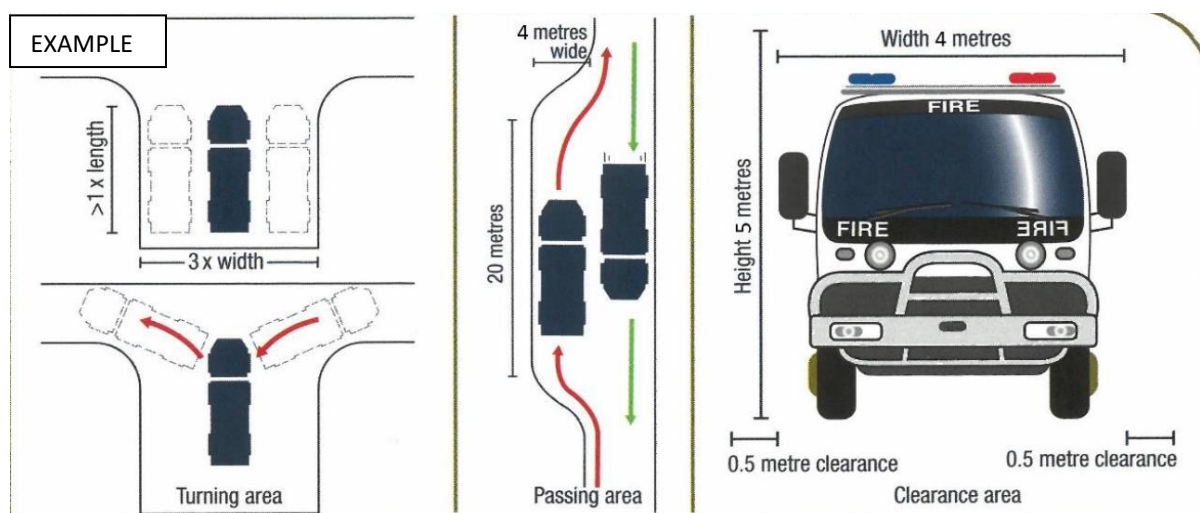
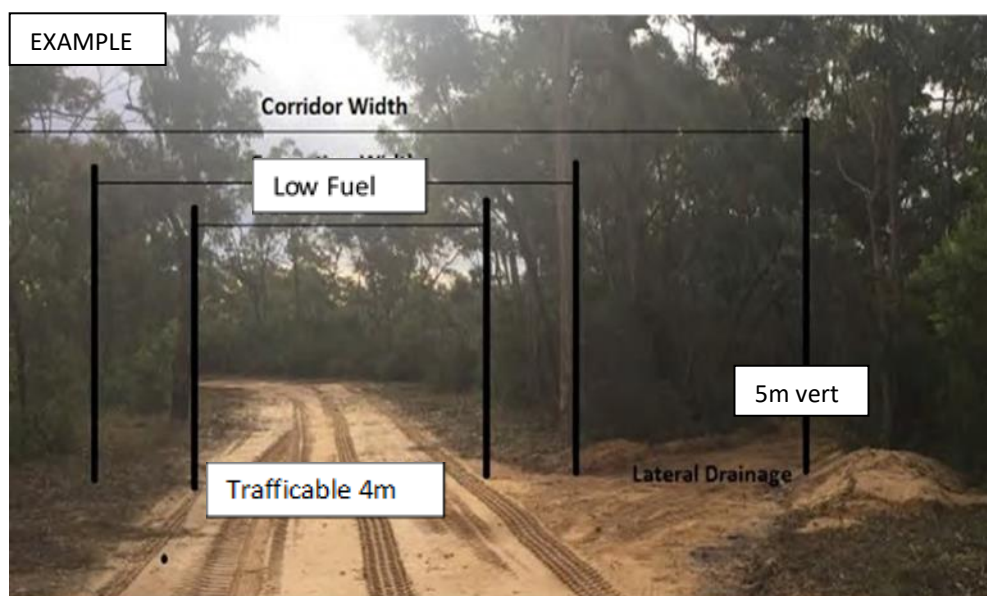

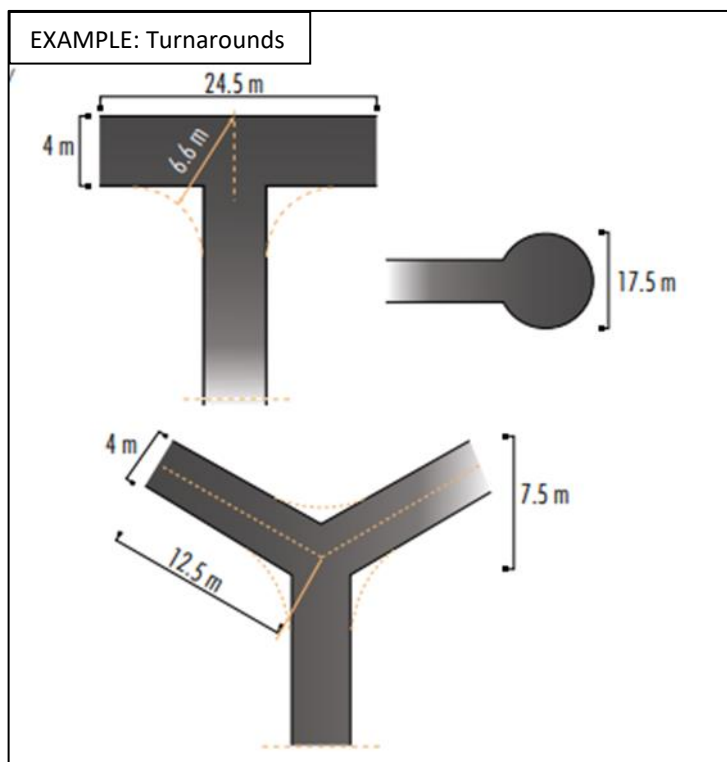

STRATEGIC BREAK

A strategic break is a gap in vegetation or other combustible material that acts as a barrier to slow or stop the progress of a bushfire or wildfire. A strategic break differs from a firebreak as it is generally of a greater width 10 – 200 meters wide (maybe more, depending on vegetation and requirement). It is mainly used to break up large areas of bushland to allow back-burning and access for firefighting operations. Is also used as a buffer zone between Urban-Rural interface and high risk communities to reduce fire intensity and create a low fuel zone.

Unless otherwise specified, Strategic breaks in the shire of Denmark should be:

- Mineral Earth / Slashed / Mulched / Chained / Scrub Rolled
- Generally trafficable on one edge
- Contain Contour Banks / Water Turn Outs where required
- Windrows removed from edges to ground level

Erosion Control:

- Minimise soil disturbance;
- Incorporate appropriate erosion control measures, such as catch drains or water bars, with consideration to soil erodibility class and gradient;
- Maintain formed natural drainage lines;
- Incorporate runoff tracks;
- Avoid stream flow interference; and
- Avoid potential landslip zones.

Trafficability:

- Constructed as straight as practicable;
- Minimise cross fall;
- Minimise gradient;

- Sufficiently clear of vegetation above and on either side;
- Ensure gentle curves;
- Provide passing bays;
- Avoid no-through roads; and
- Provide turnaround points.
- Where feasible, all weather 4WD construction (ie: firm base that can handle the weight of a fire truck) any soft sands or peaty/clay material will require gravel sheeting.
- Load capacity of at least 20 tonnes, including for bridges and culverts
- No cut off drains (mitre drains) to discharge or impact any private property.
- Rock rubble to be provided at crossing banks where in-situ soils are not acceptable.

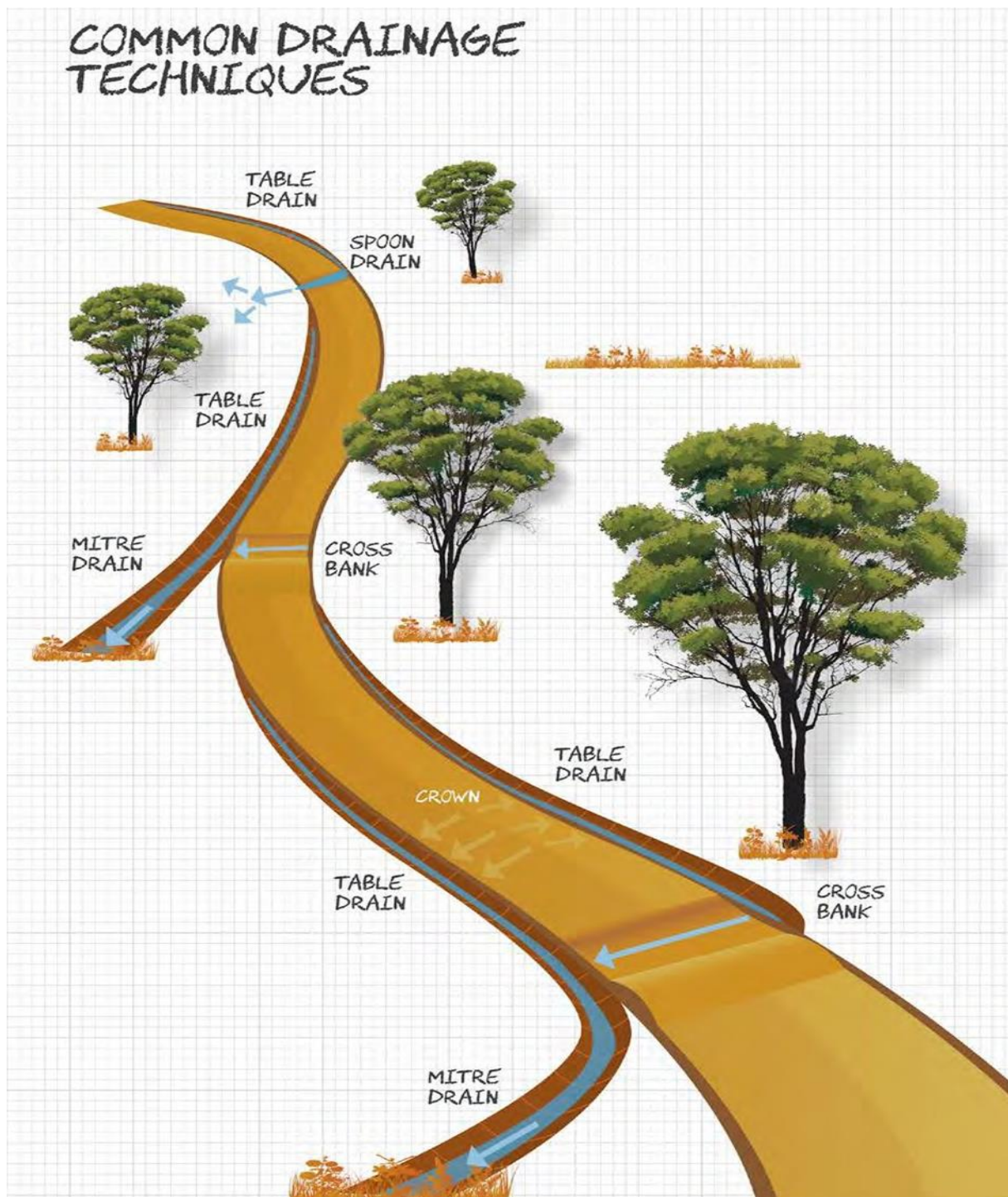

PARKLAND CLEARING

Selective clearing, parkland clearing or thinning are terms used to describe removing parts or all of the understorey and middle storeys of vegetation whilst retaining the larger trees and shrubs. Selective clearing can range from minor disturbance of the natural environment to comprehensive clearing of all but the largest trees in a landscape.

There is no set standard for “Parkland Clearing” although as a minimum the Shire of Denmark requires:

- Understory to be pruned to a height of two (2) meters from the ground
- All ladder fuels removed or mulched
- Ground vegetation to be no more than 50mm in depth
- Care to be taken not to damage large standing vegetation (ringbarking trees etc.)



MULCHING

Mulching reduces the potential for wildfires by eliminating small leafy plants, fallen or rotten trees, and other fuel sources. If left untreated, these fuel loads increase potential for fire, increase the heat intensity, and serve as fire ladders that enable fire to elevate quickly to the tops of trees which is where a fire can spread most quickly. Mulching can also be used to create a coarse grind finish that can create a more ideal controlled burn.

Unless otherwise specified, the Mulching standard in the Shire of Denmark is:

- Ground Vegetation to be no more 50mm in height;
- Care to be taken not to damage large standing vegetation (ringbarking trees etc.);
- Follow up spraying to maintain low fuel area;

Warning: Due to the mechanical nature of mulching care needs to be taken in hot, dry weather conditions. If mulching in rocky, granite areas there is a high risk of sparks and potential for fire.



SLASHING

Slashing is the use of a mechanical slasher either attached to a tractor / bobcat or to a brush-cutter to remove exposed vegetation. This rarely kills the plant but allows easier access to follow up control of the inevitable regrowth. Slashing also provides a low fuel buffer zone to reduce fire intensity and flame height. The low fuel area created allows access for fire vehicles for prescribed burning activities or wildfire suppression.

Unless otherwise specified, the Slashing standard in the Shire of Denmark is:

- Ground Vegetation to be no more 50mm in height;
- Care to be taken not to damage large standing vegetation (ringbarking trees etc.);
- Follow up spraying to maintain low fuel area;

SLASHING



CHEMICAL SPRAYING

Weed control can be achieved by the use of herbicides. Selective herbicides kill certain targets while leaving the desired vegetation relatively unharmed. Some of these act by interfering with the growth of the weed and are often based on plant hormones.

Herbicides are generally classified as follows:

Contact herbicides destroy only plant tissue that contacts the herbicide. Generally, these are the fastest-acting herbicides. They are ineffective on perennial plants that can re-grow from roots or tubers.

Systemic herbicides are foliar-applied and move through the plant where they destroy a greater amount of tissue. Glyphosate is currently the most used systemic herbicide.

Soil-borne herbicides are applied to the soil and are taken up by the roots of the target plant.

Pre-emergent herbicides are applied to the soil and prevent germination or early growth of weed seeds.

Unless otherwise specified, Chemical Spraying must

- Be carried out by a licenced technician;
- Have a non-chemical assessment carried out beforehand and implemented if viable;
- If using spray drift technique, it must be ensured that non targeted vegetation is not affected.



DIEBACK

Dieback is a disease that results in the slow death of vegetation and is caused by the introduced Phytophthora fungus. This fungus is spread by the movement of spores in water, and by human activity that moves infected soil. Phytophthora is restricted to the south-western part of the State where approximately a third of native flora is susceptible to attack. Phytophthora cannot be eradicated once an area is infested, therefore it is imperative that road management activities avoid introducing and spreading it.

Unless otherwise specified, contractors are required to:

- Identify dieback-free and dieback-infested roadsides and sources of road building materials.
- Plan site activity for drier months where possible.
- Apply hygiene methods where there is a risk of spreading dieback.
- Use dieback-free road building materials where required.
- To be trained in Dieback Management

Dieback

Right: Mud on wheels of plant and equipment can spread dieback. (Photo DEC)

Below: Jarrah Forest destroyed by dieback. (Photo DEC)

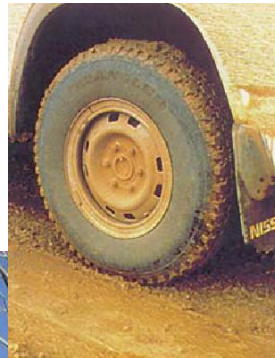

WEEDS

Weeds impede agricultural production, compete with and displace native vegetation, become a visual blight on the landscape and increase fire hazard. Weeds are classed as either “declared” or “pest plants” by regulations and require specific actions to be taken, or “environmental” that involve voluntary actions by individuals and organisations. Transport corridors such as roads are a means of spreading weeds, either by road construction and maintenance activity or by actions of road users.

Unless otherwise specified, contractors are required to:

- Apply effective weed control methods, considering site characteristics, types of weeds, weed life cycle and climatic season.
- Minimise disturbance of vegetation and soil to limit the opportunity for weed invasion.
- Manage topsoil movement to avoid spread of weeds.
- Clean equipment and vehicles before moving on/off a work site.
- Dispose of weeds at an approved disposal site.

WEEDS



TREE PRUNING/TRIMMING

Trees and other vegetation on roadsides and tracks can pose a hazard to vehicles, personnel responding to fires and encroach on the road asset in such a way as to contribute to its degradation.

Vegetation type and growth vary, so control techniques and timing of their application vary accordingly.

Unless otherwise specified, contractors are required to:

- Ensure workers understand the aim of the particular type of vegetation control and operate only within the nominated areas.
- Prune and/or remove vegetation sufficient to meet safety requirements, avoiding damage to other vegetation.
- Avoid protected environmental areas.
- Identify any revegetation areas or individual plants that need to be avoided.
- Prune for a natural finish, (eg. prune entire branch, cut tree stumps close to the ground)
- Chip and mulch cleared material or replace whole where appropriate.
- Spread mulched material on bare areas for weed/erosion control, not on existing good quality native vegetation.
- Dispose of waste vegetative material to an appropriate site, and do not burn.

Prune in accordance with the following standards:

- Use sharp tools. These will enable clean cuts and will minimise damage to the tree.
- Decide which branches are to be removed before commencing work. Ensure that you maintain a balanced, natural distribution of foliage and branches.
- Remove only what is necessary.
- Cut branches just beyond bark ridges, leaving a small scar.
- Remove smaller branches and deadwood first.

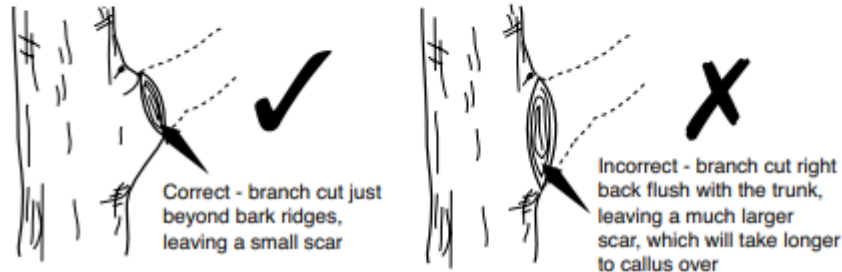

There are three primary methods of pruning trees in APZs:

1. Crown lifting (skirting)

Remove the lowest branches (up to two metres from the ground). Crown lifting may inhibit the transfer of fire between the ground fuel and the tree canopy.

2. Thinning

Remove smaller secondary branches whilst retaining the main structural branches of the tree. Thinning may minimise the intensity of a fire.

3. Selective pruning

Remove branches that are specifically identified as creating a bush fire hazard (such as those overhanging assets or those which create a continuous tree canopy). Selective pruning can be used to prevent direct flame contact between trees and assets.

ASSET PROTECTION ZONE

An asset protection zone (APZ) is an area surrounding a building that is managed to reduce the bushfire hazard to an acceptable level. The width of the required APZ varies with slope and vegetation. The APZ should at a minimum be of 20m, to ensure the potential radiant heat impact of a fire does not exceed 29kW/m² (BAL-29), it should be lot specific.

Unless otherwise specified, an Asset Protection Zone must meet the following requirements:

Fine Fuel load combustible dead vegetation matter less than 6 millimetres in thickness reduced to and maintained at an average of two tonnes per hectare.

Trees (> 5 metres in height) trunks at maturity should be a minimum distance of 6 metres from all elevations of the building, branches at maturity should not touch or overhang the building, lower branches should be removed to a height of 2 metres above the ground and or surface vegetation, canopy cover should be less than 15% with tree canopies at maturity well spread to at least 5 metres apart as to not form a continuous canopy.

Shrubs (0.5 metres to 5 metres in height) should not be located under trees or within 3 metres of buildings, should not be planted or retained in clumps greater than 5m² in area, clumps of shrubs should be separated from each other and any exposed window or door by at least 10 metres. Shrubs greater than 5 metres in height are to be treated as trees.

Ground covers (<0.5 metres in height) can be planted under trees but must be properly maintained to remove dead plant material and any parts within 2 metres of a structure, but 3 metres from windows or doors if greater than 100 millimetres in height. Ground covers greater than 0.5 metres in height are to be treated as shrubs.

Grass should be managed to maintain a height of 100 millimetres or less.

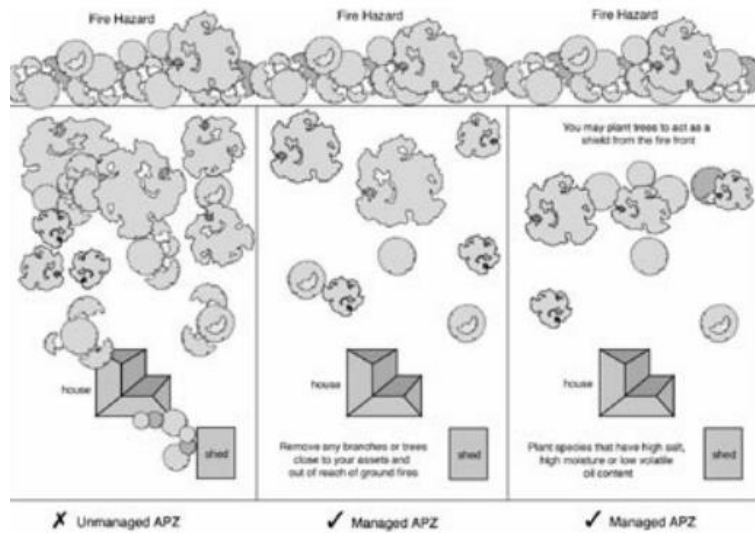

ASSET PROTECTION ZONE

